

**BAU 2025**

**> 90**

**NEW PRODUCTS  
AND FEATURES**

**> 1650**

**SQUARE METRES**

**HÖRMANN**





# Products for residential construction

**Hörmann. For Life.**





# Plaingrain surface finish

High-quality surface finish for garage and entrance doors

---

Available from 01.09.2025

## PLAINGRAIN SURFACE FINISH

Uniform look and feel for door combinations

- Smooth surface finish for a uniform look and feel of doors
- Modern with matt fine structure colours
- Particularly robust, scratch-resistant and impact-resistant
- Excellent price-performance ratio
- New addition to the Hörmann range for matching surfaces
- Available in colours:
  - 1 RAL 9016 Traffic white Matt fine structure
  - 2 RAL 9007 Grey aluminium Matt fine structure
  - 3 RAL 9006 White aluminium Matt fine structure
  - 4 RAL 7016 Anthracite grey Matt fine structure
  - 5 CH 703 Anthracite metallic Matt fine structure  
(not available for industrial sectional doors)
- Available for sectional garage doors, hinged garage doors, side sliding sectional doors with L-ribbing and M-ribbing, side doors NT 60, entrance doors Thermo65/46 and industrial sectional doors



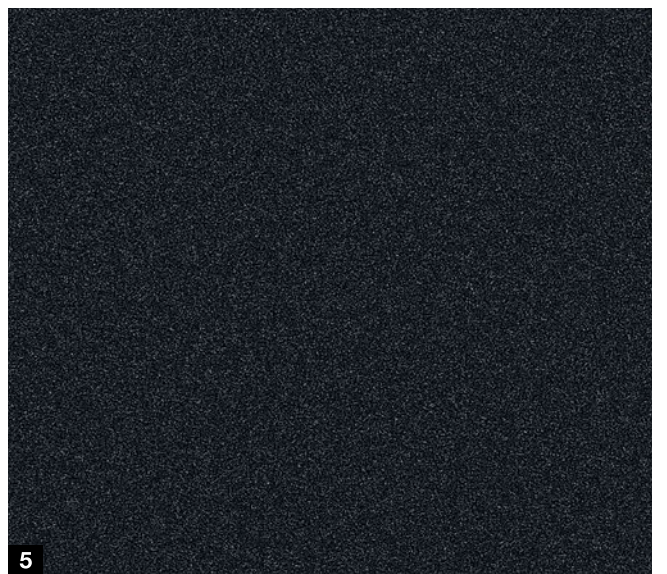
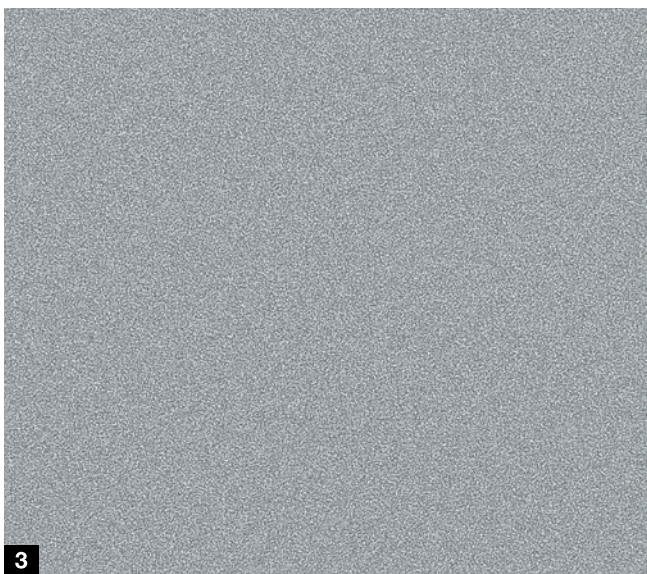
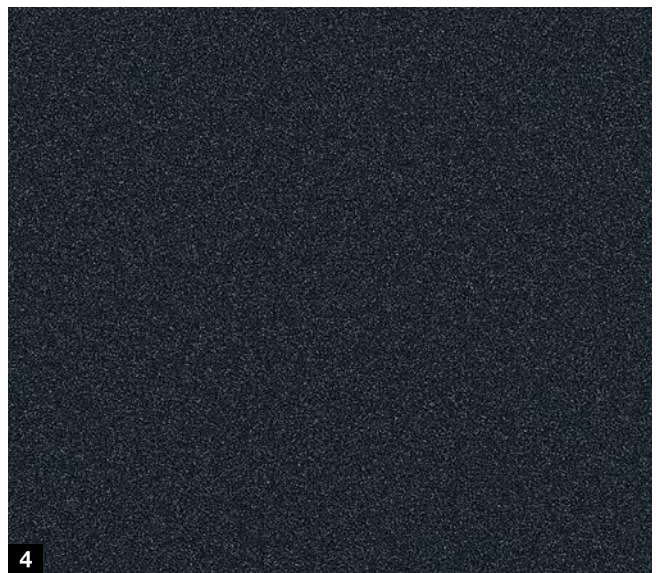
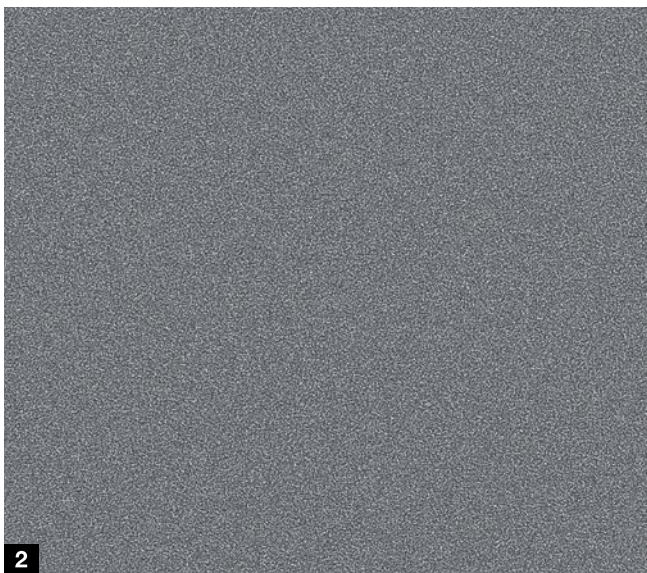



# Sectional garage doors

Design possibilities for customised door designs

---

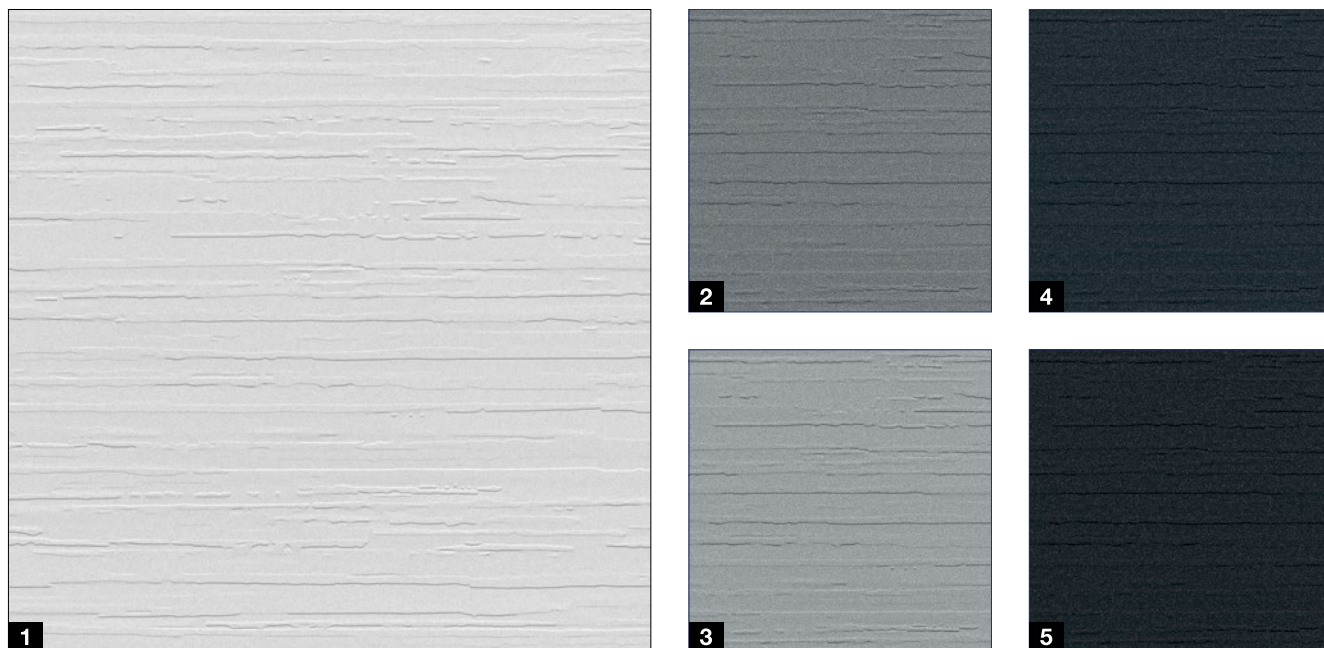

Available from 01.09.2025

## SLATEGRAIN

New matt door appearance in fine structure colours

- Surface finish with an embossed slate structure
- A more authentic appearance due to the reduced gloss level with a matt effect
- Available in colours:
  - 1 RAL 9016 Traffic white Matt fine structure
  - 2 RAL 9007 Grey aluminium Matt fine structure
  - 3 RAL 9006 White aluminium Matt fine structure
  - 4 RAL 7016 Anthracite grey Matt fine structure
  - 5 CH 703 Anthracite metallic Matt fine structure
- Available for sectional garage doors, hinged garage doors, side sliding sectional doors and side doors





**Already available**

## **VARIODESIGN**

**New design and personalisation options**

- Custom design thanks to differing sections in the door leaf with more than 30 modern Duragrain decors or 6 classic Decograins
- Flexible option with up to 3 differing sections (depending on the door size):
  - Doors with up to 4 sections: 1 differing section
  - Doors with up to 5 sections: 2 differing sections
  - Doors with up to 6 sections: 3 differing sections
- Differing sections can be in any positions
- Fascia panel and frame covering in the same colour as the base door
- Available for LPU 42 L-ribbed sectional garage doors up to 5500 mm wide in Woodgrain and Silkgrain surfaces (available now) as well as Slategrain and Plaingrain finishes (from 01.09.2025)

# Sectional garage doors

High-quality coating for harmonious door appearances

---

Available from 01.03.2025

## MORE DURAGRAIN DECORS

Timber, stone and metal decors

- Uniform appearance thanks to the 3000 mm offset in the pattern repeat, i.e. no repetition of image elements for door widths up to 3000 mm
- True-to-detail and colourfast designs thanks to the innovative Duragrain digital printing process
- High-quality coating ensures high durability and a long-lasting beautiful door view

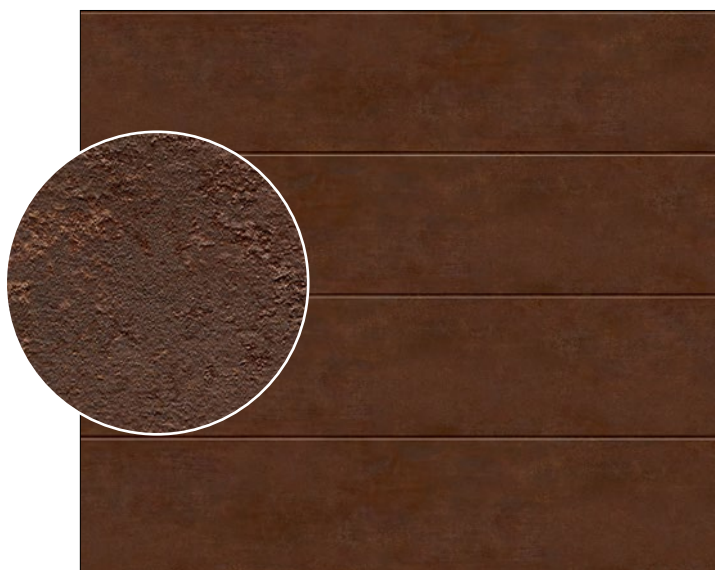
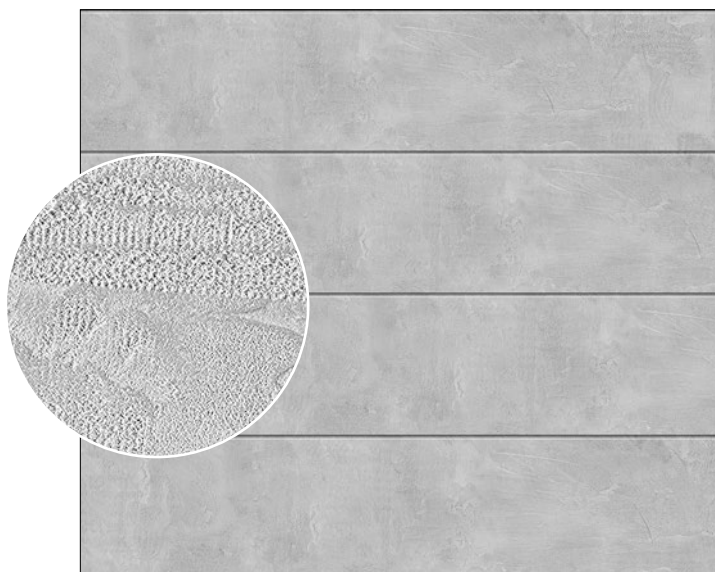



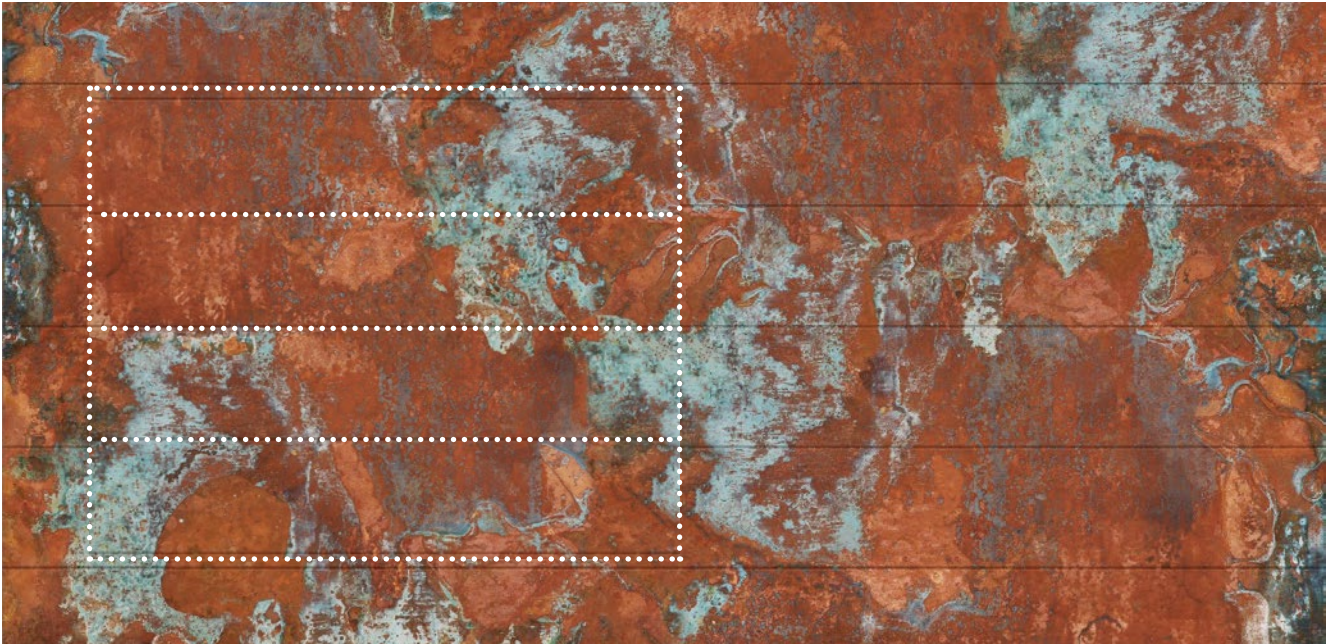

Available from 01.03.2025

## X-LARGE DURAGRAIN DECORS

Harmonious appearance without visible image repetition

- Flexible print area on the door surface can be selected from an image
- Harmonious appearance without offset in the pattern repeat or repetition of image elements
- Individual design possibilities for your garage door

# Sectional garage doors and side sliding sectional doors

Optional equipment for elegant interior views and more light

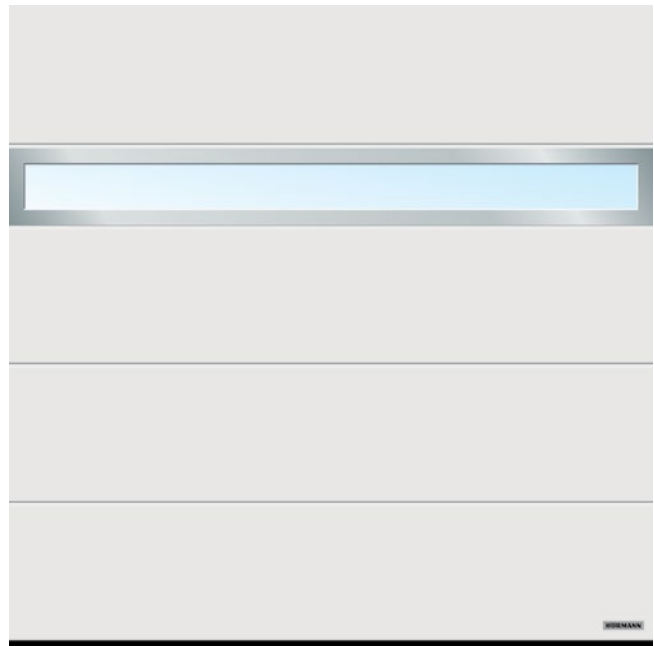

## Already available

### HIGH-QUALITY INSIDE PAINTWORK

For a uniform door appearance on the inside and outside

- In the same colour on the inside and outside of the door
- Basic variant **1**: high-quality paintwork of the internal sheet of the section
- Comfort variant **2**: additional colour coordination of end caps, door leaf reinforcements, glazing frames, ventilation grilles and styles
- Available for sectional garage doors with Woodgrain and Silkgrain surface finishes

## Available from 01.03.2025

### NARROW ALUMINIUM FRAME

New glazing in a modern design

- Narrow aluminium frame (height: 250 mm)
- Discreet, modern design
- Lets daylight into the garage
- More design and personalisation options
- Available without rails up to a clear width of 2500 mm
- Available for sectional garage doors





Available from 01.03.2025

### NEW GLAZING FRAME FOR GARAGE DOORS AND SIDE DOORS

Modern design with a stainless steel frame and black glass

- Stainless steel glazing frames with triple glazing
- Optionally available with black glass: lets daylight into the garage, prevents anyone from looking in from outside
- High-quality, modern design
- Enhanced thermal insulation properties
- Available in different sizes
- Available for sectional garage doors and garage side doors



Available from 01.03.2025

### EXPANDED OPTIONS FOR SIDE SLIDING SECTIONAL DOORS

Can be used practically as a side door

- Sliding door version with a new minimum width of 730 mm as an alternative to a hinged door
- More efficient utilisation of garages with restricted space
- Available in all colours and surface finishes

# Garage door operators and accessories

Brighter lighting for greater convenience in the garage

---







Available from 01.06.2025

## PREMIUM SUPRAMATIC H4 GARAGE DOOR OPERATOR

Powerful, smart and energy-efficient

- Fast door opening: A high operator speed of up to 250 mm/s and a pull and push capacity of up to 1000 N
- Particularly low power consumption of 0.6 watts in stand-by mode
- Energy-saving LED lighting with 60 LEDs for even brighter illumination of the garage
- Intelligent operating options with hand transmitter HSE4 BS, a Bluetooth receiver as standard for control via the Hörmann BlueSecur app on a smartphone and the integrated HCP bus interface for networking with external Smart Home systems
- Fully automatic garage ventilation with the integrated “ventilation position” in combination with an optional climatic sensor and the folding roller bracket from Hörmann
- Secure locking of the door in the ventilation or partial opening position possible in combination with the ETV1 locking element
- Available for doors up to a size of 7000 × 3000 mm

# Garage door operators and accessories

More light and greater security in the garage

---



Available from 01.03.2025

## LED-STRIPES FOR SECTIONAL GARAGE DOORS

For more light and improved visibility in the garage

- Additional interior lighting in the garage
- Bright natural-quality lighting with neutral white light
- Quick and easy fitting to the tracks of the door using integrated magnets
- Can be controlled via an additional relay in combination with a garage door operator or an on-site switch; alternatively, it can be used independently via a radio relay receiver
- Available as sets: power supply unit with 2 × 2 m + 2 × 1 m stripes or power supply unit with 2 × 2 m + 2 × 1 m stripes and external connection relay HOR1-HCP
- Available for door widths up to 6000 mm





Available from 01.03.2025

### IT3-1 MOTION INTERNAL PUSH BUTTON WITH MOVEMENT DETECTOR

Automatic light control for maximum convenience

- Integrated movement detector: switches the light on automatically when entering the garage
- Side switch to switch the movement detector on and off
- Illuminated button for convenient and simple operation of the door
- Complete switch-off option, e.g. while on holiday
- Compatible with Hörmann SupraMatic 4, ProMatic 4 and RollMatic 2 garage door operators



Available from 01.03.2025

### HAS1 ALARM SENSOR

Break-in message thanks to intelligent alarm technology

- Alarm encoder for garage doors for maximum security and reliable protection in the event of attempted break-ins
- Securing of garage doors also in the ventilation position / partial opening position
- The alarm is triggered immediately if the door is raised manually without a travel command
- Easy installation: the sensor and alarm encoder are attached to the HCP bus interface of the Hörmann SupraMatic 4 or ProMatic 4 operators via adapters

# Aluminium entrance doors

Subtle details for an exclusive door view

---







Available from 01.03.2025

**EXTERIOR ROSE ESCUTCHEON  
MADE OF STAINLESS STEEL AND  
DRILL-PROOF PANEL**

Discreet, elegant design

- Exterior rose escutcheon made of stainless steel as standard for the ThermoSafe and ThermoSafe Hybrid aluminium entrance doors
- Optional: matching drill-proof panel in black for ThermoSafe, ThermoSafe Hybrid, ThermoPlan Hybrid and ThermoCarbon
- Exterior rose escutcheon and drill-proof panel for security class RC3

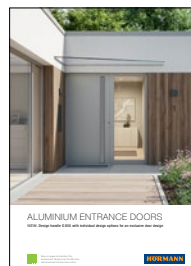

For further information, see the  
“Aluminium entrance doors” brochure.

## Aluminium entrance doors

Innovative handle design for a modern door view

---

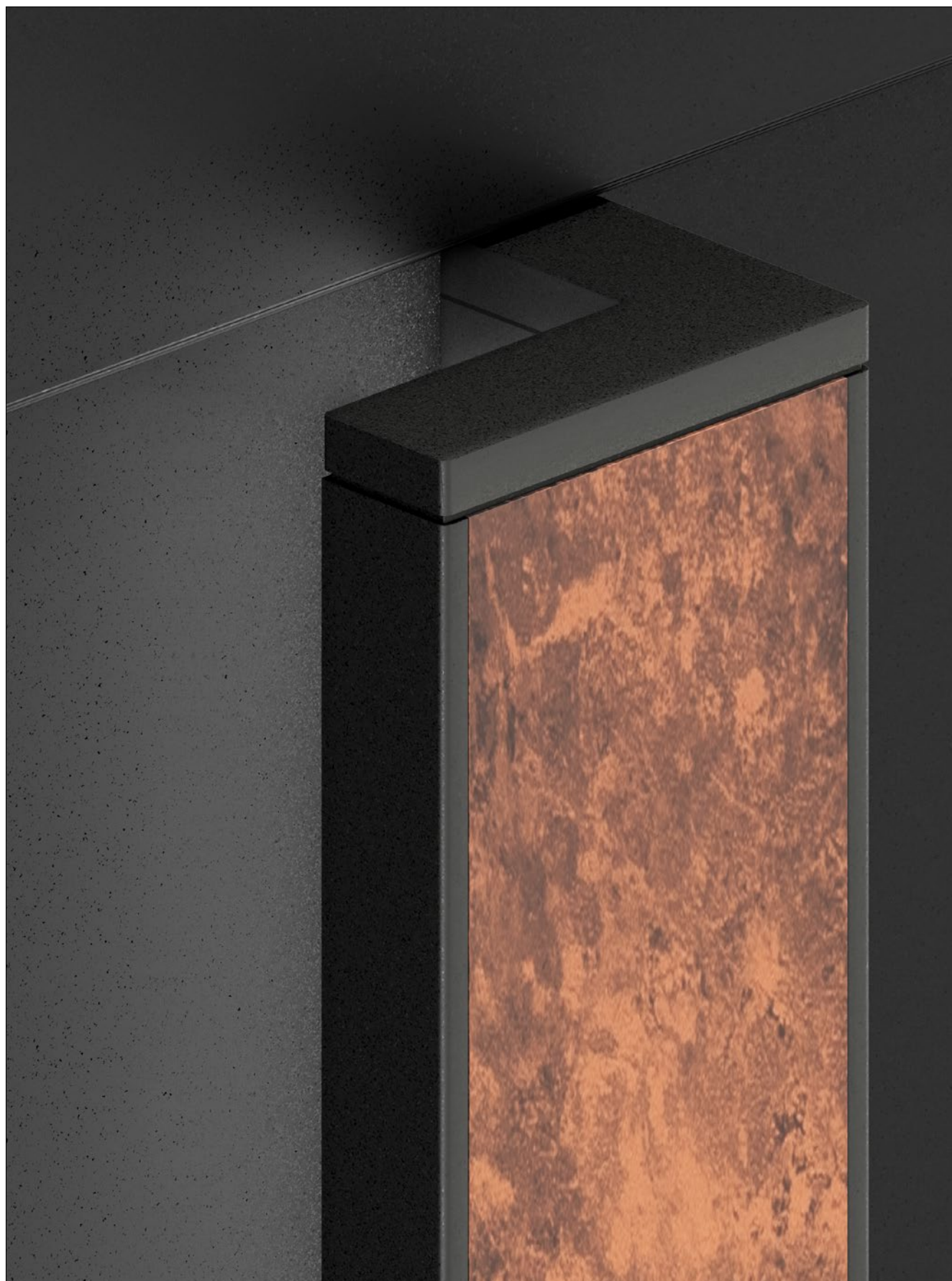





Available from 01.03.2025

## BAR HANDLE G850

Modern design with smart additional options

- Angular, modern design can be combined with smart add-on packages
- A wide variety of design options: flush-fitting applications in MatchDecor decors Rusty Patina, Wild Oak and Barnwood as well as in stainless steel and RAL to choose
- Available in different lengths: handle in door height, in a length of 1000 mm and in variable length
- Smart G850 version in door height, optionally with finger-scan **1** at the front or back
- LED strip can optionally be integrated
- Available for ThermoSafe, ThermoSafe Hybrid and ThermoPlan Hybrid, ThermoCarbon aluminium entrance doors

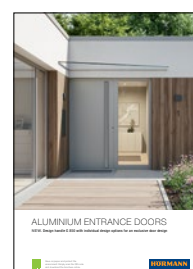

For further information, see the "Aluminium entrance doors" brochure.

# Aluminium entrance doors

Design possibilities and operation options for light, design and comfort



Available from 01.03.2025

## DOOR STYLE 137

Large glazing cut-out lets daylight inside

- Large glazing cut-out with clear stripes in sandblasted glass
- Ideal for entrance areas without the space for a side element or window
- Harmonious appearance with stainless steel handle HOE 735 matched to the glazing height
- Available for ThermoSafe, ThermoSafe Hybrid and ThermoPlan Hybrid aluminium entrance doors

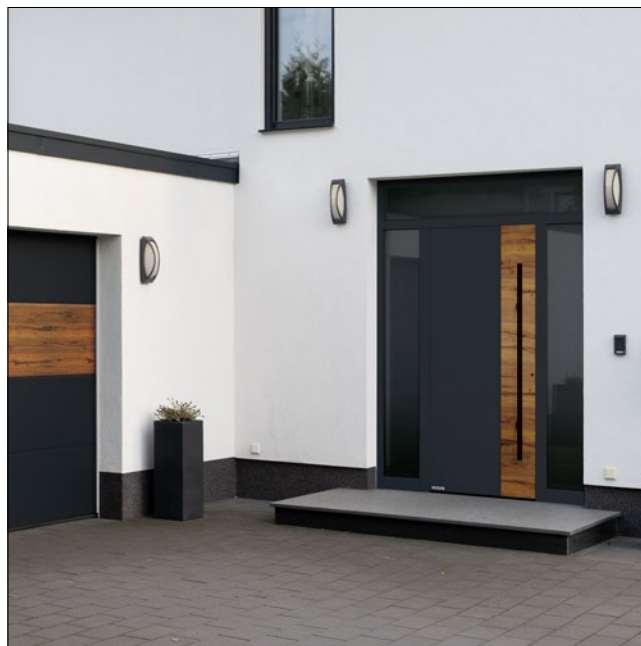

Available from 01.03.2025

## DOOR STYLE 878

Individual design with two surfaces

- Modern, two-colour design with flush-fitting applications in the door leaf
- Applications in MatchDecor decors Rusty Patina, Wild Oak and Barnwood as well as in stainless steel and RAL to choose
- Wide selection of handles for a variety of design options
- Available for ThermoSafe and ThermoSafe Hybrid aluminium entrance doors



For further information, see the "Aluminium entrance doors" brochure.





Available from 01.04.2025

## FLOOD-RESISTANT DOORS

Protection in the event of flooding

- Up to 500 mm water level
- Optional accessory package (also for retrofitting)
- Available for single-leaf ThermoSafe Hybrid aluminium entrance doors opening outwards with a door width of up to 1250 mm (without side elements)



Available from 01.03.2025

## FINGERSCAN FOR ENTRANCE DOORS

Smart opening of the entrance door without a key

- A keyless access control system via fingerprint
- Maximum security, fast finger recognition and reliable functionality
- Innovative area sensor technology for effortless opening without a key
- Modern, inconspicuous design
- Two fitting variants: Flush-fitting in the door leaf or lever handle (shown on page 19) or concealed and practically invisible on the back of the handle (shown above)
- Available for all aluminium entrance doors and Thermo65 steel / aluminium entrance doors

# Thermo65 steel / aluminium entrance doors

Functional handle design for elegant door views and greater convenience

---



Available from 01.03.2025

## EXTERIOR HANDLE HOE 600

Modern and minimalist look

- Elegant handle in high-quality, brushed stainless steel
- Handle length: 1000 mm
- Clear, straight-lined design for a contemporary door look
- Flat, rectangular design for a minimalist door view
- Additional clearance for easy operation of the profile cylinder
- Convenient handling when opening and closing the door
- Available for Thermo65 steel / aluminium entrance doors





Available from summer 2025

### **PUSH BAR WITH LED ILLUMINATION**

Convenient opening of your entrance door  
even in the dark

- Optimum illumination of the profile cylinder
- Integrated, battery-operated movement detector
- Illumination automatically activated for 15 seconds
- Handle length for push bar 39-1: 1000 mm
- Handle length for push bar 15-1: 400 mm
- Available for Thermo65 steel / aluminium entrance doors (also for retrofitting)

# Steel / aluminium entrance doors

New design variants for custom entrances

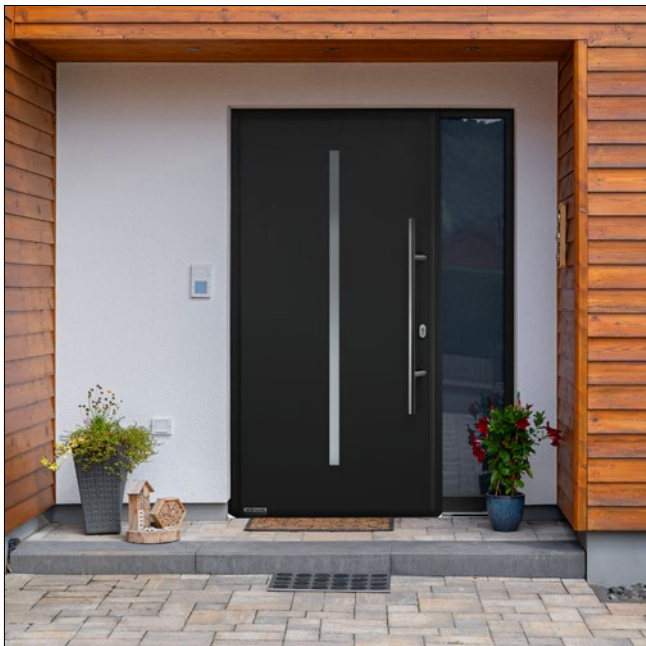

Available from 01.03.2025

## Style 640S

Minimalist design

- Slim, frameless glazing cut-out (50 mm) and glazing on the inside
- Optionally with satin-finished glass or black glass
- Good thermal insulation: no thermal bridge between glass and foam filling due the glass being located on the inside
- Optionally available in class 3 (42 dB) with soundproofing package
- Available as Thermo65 steel / aluminium entrance door



Available from 01.03.2025

## Style 650S

Elegant glazing cut-out in the door leaf

- Slim glazing cut-out in the door leaf (40 mm)
- Stainless steel frame on the outside (40 mm)
- Optionally with satin-finished glass or black glass
- Good thermal insulation: no thermal bridge between glass and foam filling due the glass being located on the inside
- Optionally available in class 3 (42 dB) with soundproofing package
- Available as Thermo65 steel / aluminium entrance door



Available from 01.03.2025

### STYLE 750C BLACK.EDITION

Strong contrasts in black and white

- Glazing frame, handle, closing rose escutcheon and profile cylinder in black
- Different handle variants
- Modern door view thanks to strong contrasts
- Available as Thermo65 steel / aluminium entrance doors



Available from 01.03.2025

### DOUBLE-LEAF ENTRANCE DOOR WITH SMALLER FIXED LEAF

More flexibility in limited space

- Fixed leaf from 700 mm width
- Excellent thermal insulation
- Available for Thermo65 steel / aluminium entrance doors



# Storage space systems

More space in the garden thanks to practical details



Available from 01.03.2025

## JUNO TOOL SHEDS

Good price / performance ratio and many sizes

- Robust design consisting of single-skinned, galvanized, high-quality painted sheet steel
- Weather-resistant, rainwater-proof and UV-resistant thanks to high-quality coil coating on both sides
- Particularly low maintenance and easy to clean
- Wide range of design possibilities thanks to two roof shapes (flat and gable roof) and two styles (Modern and Design)
- Flat roof with 11 sizes, gable roof with 14 sizes
- 3 modern exterior colours: Grey aluminium RAL 9007, Anthracite grey RAL 7016, Titan metallic CH 703
- Harmonious appearance thanks to concealed hinges
- Mechanical hold-open device for controlled opening and closing

### Versions

- 1** Modern flat roof
- 2** Design gable roof



Available from 01.03.2025

## VARIO STYLE FOR BERRY TOOL SHEDS

Various designs thanks to on-site cladding

- On-site cladding means you can choose your own individual infills
- The tool shed can be perfectly matched to the style of the garden
- Available for gable roof **1** and pent roof **2**
- Available in three sizes to meet your particular space needs
- Robust design consisting of single-skinned, galvanized, high-quality painted sheet steel
- Quick and easy fitting thanks to maximum degree of prefabrication
- Particularly low maintenance and easy to clean
- Perfectly neat and tidy thanks to a range of practical accessories

# Steel doors

More light and comfort for secure side doors



Available from 01.03.2025

## DOUBLE-LEAF MULTI-PURPOSE DOOR

Now also with glazing and ribbing

- Style 015 with ribbing for an exclusive door view
- Style 025, 610 with glazings for more light indoors
- Traffic leaf and fixed leaf optionally with different styles **1**
- Flush-fitting transition between the traffic leaf and the fixed leaf without visible centre rail
- Around 49% better thermal insulation compared to conventional multi-purpose doors
- Door leaf and frame with thermal break to prevent condensation in heated rooms
- Optionally with anti-panic function B (change-over function)
- Available as multi-purpose door MZ Thermo65

### New styles / style combinations

- 1** Traffic leaf style 015 or fixed leaf style 025
- 2** Traffic leaf and fixed leaf style 610





Available from 01.03.2025

### NEW LOCK VARIANTS ADDED FOR FS THERMO65

Automatic lock and additional multiple-point lock

Automatic lock with motor:

- Unlocking possible via hand transmitter, smartphone, radio finger-scan, code switch or intercom system
- Increased security thanks to self-locking function

Further equipment options:

- Multiple-point locking (hook bolt) with electric strike



Available from 01.03.2025

### STEEL SECURITY DOOR KSI THERMO65

Good thermal insulation plus RC2 security features

- 65 mm thick door leaf with thermal break provides even better thermal insulation
- As standard in tested RC2 security class
- Optionally with acoustic insulation up to 42 dB (acoustic rating category 3)
- Wide range of designs: Traffic white (RAL 9016), MatchColor, Color, Matt deluxe shades and Decograin decors
- Ideal as an external door for basements, heated buildings or garages with access to the house

# Residential internal doors

Stylish door design for your home



1



Available from 01.03.2025

## DESIGNLINE BRISK

### Black joints for a stylish accent

- Over 40 styles, matches the Groove / Line styles, for stylish highlights in your home
- Black, milled joints in a solid-coloured cover plate
- Particularly elegant with the black lever handles and fittings from the Hörmann black.edition
- Real wood-veneers made of high-quality real wood for a natural look
- Real lacquer surface finish with a slightly glossy colour effect for a sophisticated door view
- Robust Duradecor surface finish (White lacquer, Dusty grey, Alpine Oak, North Oak, Natural Oak) with an impact resistance that is on average 48% better compared to CPL surfaces from other manufacturers
- Available as flush or rebated residential internal doors

### Attractive style

- 1** DesignLine Brisk 15 knotty oak matt real wood veneer
- 2** DesignLine Brisk 39 real lacquer, Traffic white RAL 9016
- 3** DesignLine Brisk 29 knotty oak matt real wood veneer
- 4** DesignLine Brisk 23 Duradecor, White lacquer RAL 9016
- 5** DesignLine Brisk 31 knotty oak matt real wood veneer



# Residential internal doors

Elegant door views for individual room design options

---





Available from 01.03.2025

## DESIGNLINE LINE

Individual designs with milling on the door leaf

- Maximum design freedom with over 30 styles, matches the Groove styles
- Precisely milled 9 mm wide joints **1** in the door leaf (4.5 mm groove width **2** in DesignLine Groove)
- The vibrant real lacquer surface finish ensures a high-quality door view
- Available as flush or rebated residential internal doors



Available from 01.03.2025

## THREE MODERN DESIGNS FOR DESIGNLINE GROOVE / LINE

Precise milling for a high-quality door view

- Modern door design for an individual room design
- The vibrant real lacquer surface finish ensures a high-quality door view
- Available as flush or rebated residential internal doors

### New styles

- 3** Style 99
- 4** Style 58
- 5** Style 59

# Residential internal doors

Elegant door views for the trendy industrial style



Available from 01.03.2025

## DESIGNLINE PALLADIO

Timber frame door combines transparency and stability

- Glass pane over the entire surface for more light and high transparency
- Stylish, sturdy timber frame with real lacquer surface finish for high stability
- Combination options with different types of glass (e.g. clear glass, tinted glass or glass pane with black lines in a modern loft design)
- Can be combined with a timber frame or sturdy steel frame VarioFix

### DesignLine Palladio

- 1 Loft design 3-5
- 2 Loft design 2-5
- 3 Loft design 1-5
- 4 Clear glass
- 5 Matt glass



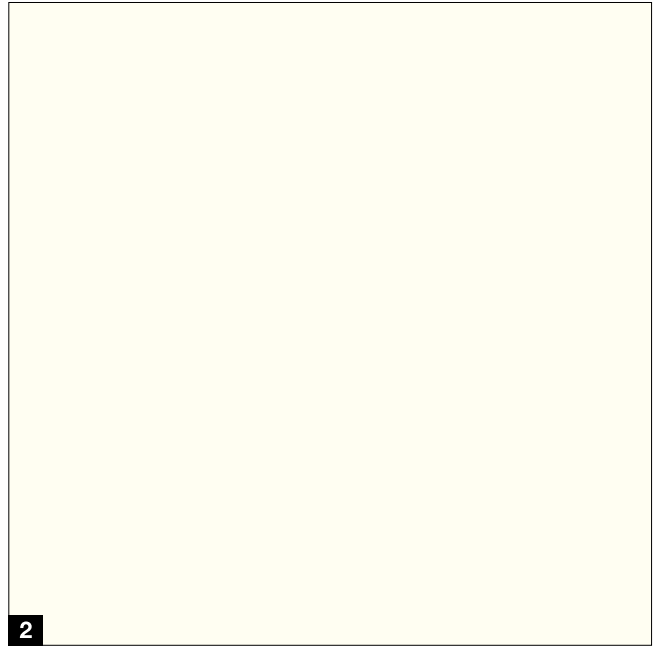
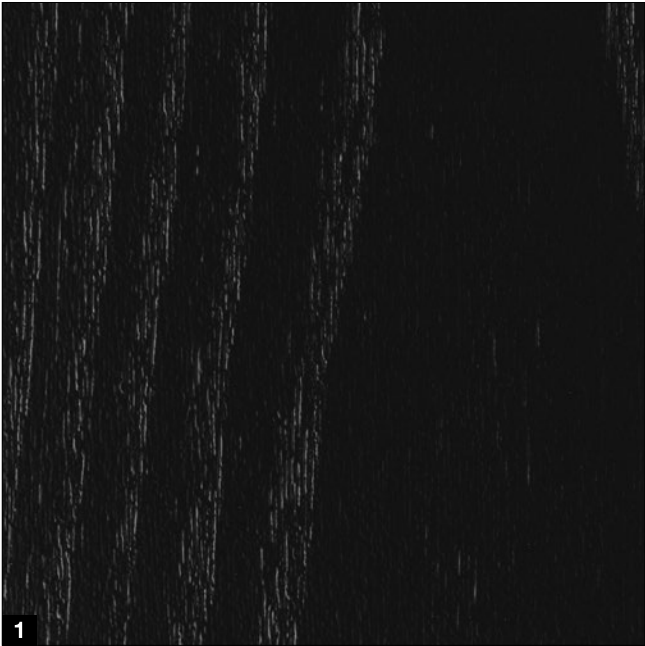

Available from 01.03.2025

## DURADecor SURFACE FINISHES

Modern door views in black or white

### **1 Duradecor Black Oak texture with vertical grain**

- Robust textured surface provides a dark contrast in your home
- Stylishly combines a feeling of real wood with ease of care
- Palpable wood grain embossed into the door leaf

### **2 Duradecor Pure white RAL 9010**

- Warm white, ideal for construction projects

# Residential internal doors

Exclusive design for a minimalistic door view

---



Available from 01.03.2025

## DESIGNLINE SLAT

A streamlined design without lever handles

- With insert in the door leaf (horizontal **1** or vertical **2**) as a discreet handle for opening and closing
- Magnetic guard lock for secure door closing
- Streamlined appearance thanks to the lack of conventional lever handles
- Various surface finishes to choose from: real lacquer and Duradecor
- Door leaf in real lacquer surface finish with a matt or slightly glossy colour effect for a sophisticated door view

# Residential internal doors

Individual door design at entry-level prices

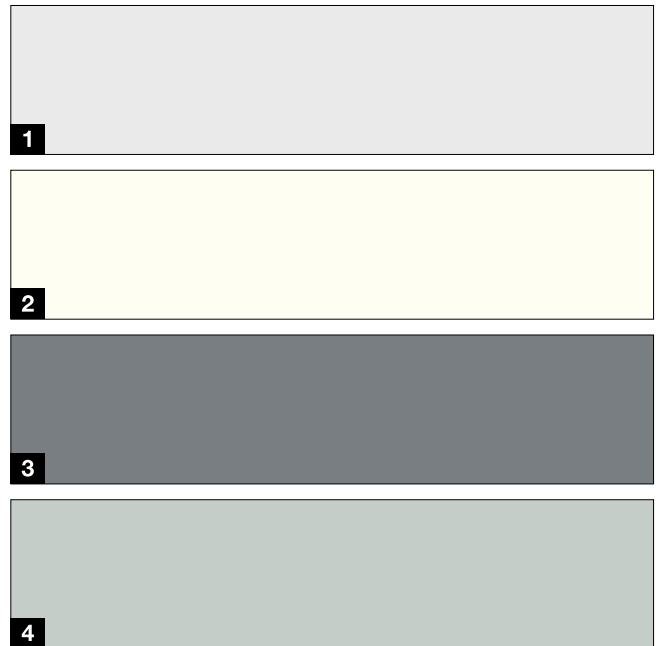

Available from 01.03.2025

## DOOR SERIES BASELINE

A variety of styles at an attractive price

- BaseLine with smooth door leaf in angular and rounded edge version for a simple and elegant look
- BaseLine Slim 15 with angular edge version and modern four-stripe look
- BaseLine Carolina Light with angular edge version for the country house style
- Supplied as a complete package: rebated door leaf with insert made of high-quality tubular or solid chipboard, timber frame and stainless steel lever handle (without closing rose escutcheon)

### Surface finishes and colours

#### BaseLine

- 1 Traffic white RAL 9016 decor surface finish
- 2 Pure white RAL 9010 decor surface finish
- 1 Traffic white RAL 9016 roller lacquer surface finish
- 2 Pure white RAL 9010 roller lacquer surface finish
- 3 Dusty grey RAL 7037 roller lacquer surface finish
- 4 Light grey RAL 7035 roller lacquer surface finish

#### BaseLine Slim 15

- 1 Traffic white RAL 9016 lacquer surface finish

#### BaseLine Carolina Light

- 1 Traffic white RAL 9016 lacquer surface finish



# Residential internal doors

Elegant design with practical details



Available from 01.03.2025

## EURO LEVER HANDLE PRO

Particularly high quality and suitable for heavy wear

- Modern Euro lever handle Pro in a round **3 4** or angular **5 6** version
- Minimalist door view without closing rose escutcheon
- Optional ProLock locking mechanism: integrated practically invisibly on the inside of the lever handle, for locking and unlocking the door directly via the handle **1**
- Optional ProLockPlus locking system: lock on the outside of the lever handle, for locking and opening the room with a key **2**
- Emergency opening possible on the opposite side
- Stress class 3
- Lever handle hole prepared at the factory for particularly fast and simple fitting as standard
- Available in a choice of stainless steel **3 5**, Jet black RAL 9005 **4 6** (black.edition) or brass (further information can be found on page 40)
- Available for residential internal doors from the ProLine <sup>1)</sup>, DesignLine <sup>1)</sup> and ClassicLine <sup>2)</sup> series

<sup>1)</sup> Except for apartment entrance doors

<sup>2)</sup> Except for the Carolina series

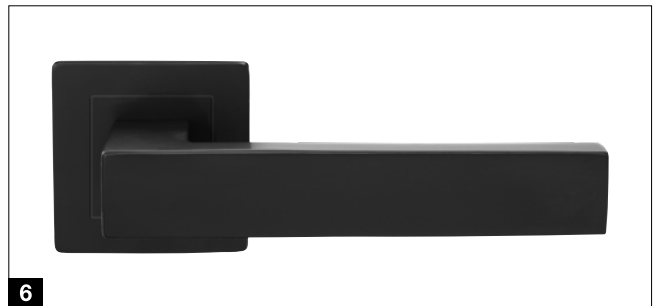
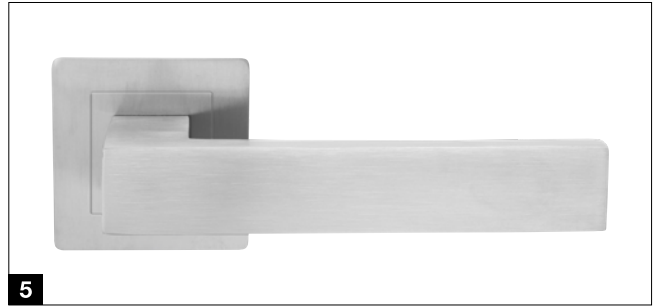

# Residential internal doors

High-quality equipment for individual door views

---



Available from 01.03.2025

## EURO COMFORT LOCK

Magnetic comfort lock for gentle and quiet closing

- Door closing without mechanical friction
- Short lock cover for a discreet door view
- Low wear due to the innovative magnetic mechanism
- Available in stainless steel, black and brass
- Available for flush-fitting Hörmann residential internal doors

Available from 01.03.2025

## DOOR FITTINGS AND LEVER HANDLE SETS IN BRASS

Timeless elegance

- Lever handles, hinges and lock plates made of high-quality brass
- For a touch of luxury and timeless elegance
- Available for flush-fitting Hörmann residential internal doors





Available from 01.03.2025

## DURAPROJECT SURFACE FINISHES WITH BEECH BATTEN AND DURAPROJECT DOOR FRAME

Durably beautiful door view even for particularly demanding applications

- Beech batten visible in door leaf edge for additional stability and resistance
- With robust steel case frame VarioFix or matching DuraProject door frame
- Inexpensive alternative to HPL surfaces offering the same tested properties
- Tested and certified according to DIN EN 438-3 by the Entwicklungs- und Prüflabor Holztechnologie GmbH (EPH) in Dresden, Germany
- Particularly impact-resistant, wear-resistant and scratch-resistant as well as resistant to light, heat and vapour
- Ideally suited for schools, kindergartens, offices and high-quality residential buildings
- Available for flush and rebated timber doors with smooth and textured surfaces in the colours Traffic white RAL 9016, Light grey RAL 7035 and Dusty grey RAL 7037



# Loft doors

Stylish details for the trendy industrial style

---

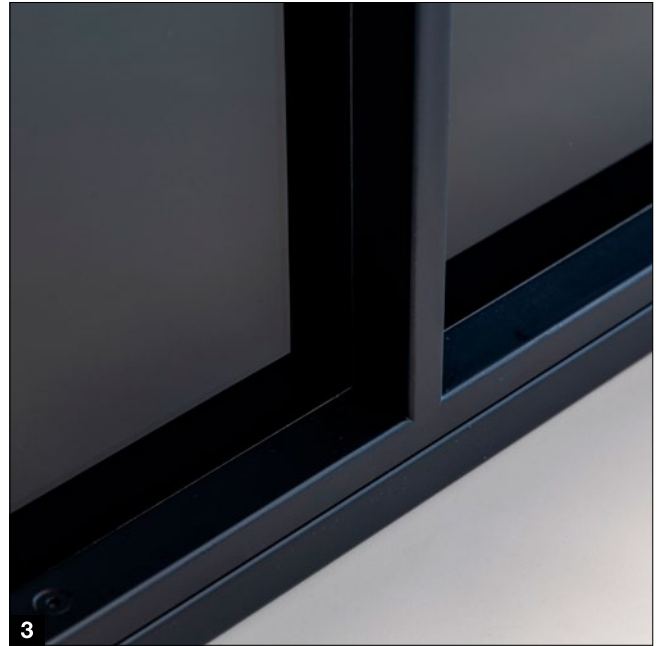

Available from 01.03.2025

## STEEL LOFT DOORS

More design options and flexibility

- Hinged doors available with 3-way adjustable screw-on door hinges as standard **1** to allow the door to be adjusted flexibly
- Different colours of door frames and glazing beads **2** for more design variety
- Extended selection of glass infills with tinted glazing **3** and mirror glazing
- The new handle HL G-19 with a minimalist design and a length of 150 mm, welded to the horizontal rail, available in the colour of the door



Available from 01.03.2025

## MAGNETIC OPERATOR FOR LOFT SLIDING DOORS

Efficient and quiet

- Maintenance-free operation making it particularly long-lasting
- No pre-installation required – simple and time-saving fitting and initial start-up
- Efficient and quiet thanks to the lack of mechanical gearbox
- No sensor due to low motion energy
- Flexible control options via hand transmitter, radar sensor, internal push button or movement detector
- Smart access control with finger-scan, code switch or transponder

Available from 01.03.2025

## GLASS DOOR IN THE LOFT DESIGN

Lost design thanks to enamelled glass pane

- Single-leaf sliding door with enamelled glass panel in loft design
- Inexpensive alternative to steel loft doors
- Lightweight for simple fitting and ergonomic operation
- Ease of care and cleaning of the enamelled glass





# Products for construction projects

**Hörmann. For Life.**



# Box frame construction project doors

Maximum transparency for individual requirements

---



Available from 01.06.2025

## ALUMINIUM PARTITION SYSTEM WITH TRANSOM LIGHT

Any width extension possible

- Version with transom light for maximum transparency
- Elegant partitioning of office areas or meeting rooms
- Available with and without smoke protection





Available from 01.03.2025

## ALUMINIUM SYSTEM WALL “ECONOMY” WITH SWITCHABLE GLASS

Privacy at the push of a button

- Cost-effective Hörmann Vitrafire EI<sub>2</sub>30 glazing
- Optionally with switchable glass
- For switching between transparency and privacy

# Box frame construction project doors

Improved functions for special demands



Available from 01.06.2025

## T90 ALUMINIUM BOX FRAME CONSTRUCTION PROJECT DOORS WITH STEEL FRAME

Fire protection, break-in resistance equipment and escape route

- Combination of resistance classes RC2 or RC3 and escape route function possible
- Fitting with robust steel frame for up to 70 mm more clear passage width

\* In comparison to an aluminium box frame construction project door with fascia frame



Available from 01.09.2025

## FRAME WITHOUT FACE FOR ALUMINIUM BOX FRAME CONSTRUCTION PROJECT DOORS

Narrow profile views, break-in-resistant escape doors, large escape route widths

- Slim one-part profile system
- Glazing beads on opposite hinge side
- Ideal to meet requirements for narrow profile views, RC2 or RC3 break-in-resistant escape doors and large escape route widths

**Only from Hörmann**



Available from 01.03.2025

## T90 STEEL BOX FRAME CONSTRUCTION PROJECT DOORS WITH MODIFIED PROFILE SYSTEM

New depth of 70 mm

- Steel box frame construction project doors HL 910 and HL 920
- Modified profile system based on the proven N-Line system with a depth of 70 mm
- Cost-effective and flexible equipment variants with short delivery times
- Version as fire-proof T90 / RS fire-rated and smoke-tight door for application indoors
- Total frame width (frame and profile): 168 mm
- Size range: single-leaf up to RAM 1500 × 2600 mm (W × H), double-leaf up to RAM 2500 × 2600 mm (W × H)
- 3-way adjustable weld-on barrel hinge in the colour of the door
- Side elements (up to 1000 mm wide) and transom lights (up to 1000 mm high) available
- Optional version available with anti-panic fitting
- Matching the T90 and T30 steel box frame construction project doors

# Door frames and visibility windows

Well thought-out details for improved fitting options

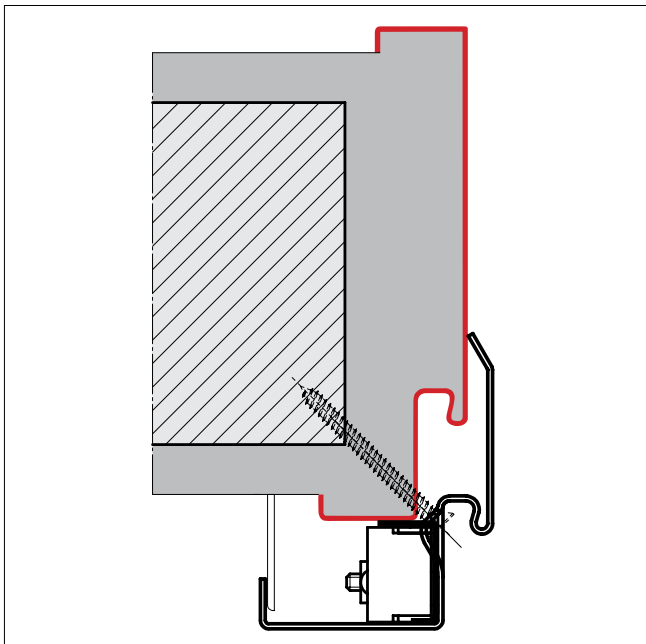

Available from 01.03.2025

## RENO DOOR FRAME

Quick door and frame replacement

- For retrofitting during renovations without dismantling the old door frame (red)
- Ideal for old or listed buildings and condominiums
- Diagonal screw connection through the rebate
- The narrow profile of the Reno door frame means that the incidence of light is only slightly reduced
- Optionally available with a primed surface finish, and optionally powder-coated in any RAL colour



Available from 01.03.2025

## HINGE POCKET STV INCLINO 3D

3-way door adjustment made easy

- Hinge pocket STV Inclino 3D for steel frames
- Simple and precise setting thanks to 3-way door adjustment via a tilting function
- Can be combined with standard frame parts of hinges of series V 8000
- For use in all common frame profiles
- For rebated and flush door leaves from 40 mm
- Suitable for heavy internal and construction project doors up to 70 kg





Available from 01.06.2025

## VISIBILITY WINDOW WITH PRE-ASSEMBLED FRAMES

Easy integration - fast fitting

- Vertical profile construction for flexible partitioning
- Quick and easy fitting as well as dismantling in drywalls
- Different module sizes and configurations available, e.g. as corner glazing
- Maximum glazing size: 1500 mm × 3000 mm (landscape or portrait format)
- Acoustic insulation 35 dB to 38 dB with single glazing, 46 dB to 50 dB with glazing on both sides and depending on glass selection
- Optional screen in the space between panes with glazing on both sides

# Steel construction project doors

Extended functions for individual requirements



Available from 01.04.2025

## FLOOD-RESISTANT DOORS

Protection against flooding

- Up to 900 mm water level
- Optional accessory package (also for retrofitting)
- Available for single-leaf steel construction project doors  
D65 OD, H3 OD with a door width of up to 1150 mm  
(BRM width)



Available from 01.03.2025

## DOORS FOR DATA CENTRES

OD door size range extended

- Door height up to 3000 mm (BRM height)
- Ideal for use in data centres
- Fire-retarding T30 or fire-proof T90 version, optionally with smoke protection
- Bonded door construction with thin rebate
- Door leaf thickness: 65 mm
- Available as steel construction project doors D65 OD, H3 OD and H16 OD

# Steel construction project doors

Practical solutions for special fitting requirements



Available from 01.03.2025

## CORNER AND COUNTER FRAME C TYPE 5

Frame system enveloping the wall

- Extension of a corner frame to a double-shell door frame is possible
- No offset in the frame face or in the joint in the reveal
- Fastening by means of diagonal fixing of the corner frame
- Additional fastenings such as fixing brackets on the counter frame face are not required
- Available for all steel construction project doors OD



Available from 01.08.2025

## BLOCK FRAME ETYPE 5

With 115 mm counter frame face

- Single-shell block frame with 1.5 mm sheet thickness
- Lower weight than with a double-shell block frame
- 115 mm wide counter frame face
- 90° door opening for fitting to the wall is possible
- Plug-and-screw fitting
- Available for all steel construction project doors OD





Available from 01.08.2025

### RC3 SECURITY WITH SINGLE-POINT LOCKING

*Inexpensive RC3 security*

- Lower-cost alternative to multiple-point locking with same high level of security
- Single-point locking instead of multiple-point locking for steel construction project doors with RC3 security features
- Mortice lock without reinforced bolt
- Compatible with automatic door openers



Available from Autumn 2025

### STEEL CONSTRUCTION PROJECT DOORS H60 OD AND H120 OD

*With ETA proof of usability with CE marking*

- Door version: solid leaf or with glazing
- Classified according to EI<sub>2</sub>60; EI<sub>2</sub>60-S<sub>200</sub> (H60 OD) and EI<sub>2</sub>120; EI<sub>2</sub>120-S<sub>200</sub> (H120 OD)
- Acoustic insulation up to 43 dB
- Bonded door construction with thin rebate
- Door leaf thickness: 65 mm

# Steel and stainless steel construction project doors

Elegant details for an exclusive door view

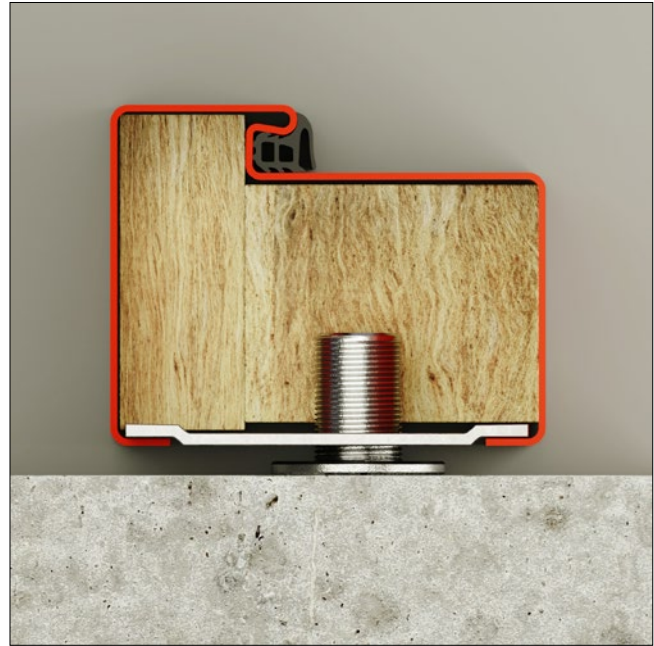

**Already available**

## FLUSH-FITTING FIRE-PROOF GLAZING FOR T30 / EI230 DOORS

For demanding construction projects and clean room doors

- Flush-fitting single-pane safety glass on both sides, fire protection glass in the middle
- All-round frieze width: minimum 215 mm width
- Can be combined with concealed hinges and integrated overhead door closer ITS
- Available for flush-closing and rebated STS / STU doors

**Already available**

## ADJUSTMENT SCREW FOR STEEL AND STAINLESS STEEL DOORS STS / STU

Quick and easy fitting of corner and block frames

- Suitable for concrete and brickwork
- For external and internal doors (in Germany not available for internal doors)
- Available for flush-closing and rebated STS / STU doors

# Steel and stainless steel sliding doors / vertical sliding doors

Well thought-out details for extended functions

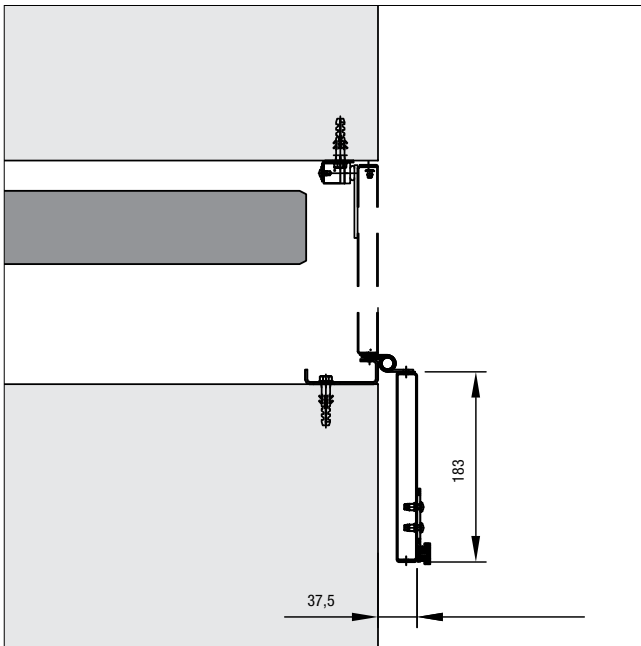

Already available

## RECESS FLAP FOR SLIDING DOORS FST WITH 180° OPENING

Free escape routes

- The escape route is only minimally restricted when the hatch is open
- Ideal for small doors with a wicket / escape door in construction projects and hotels
- Available for recess flaps at the inlet and outlet of the sliding door

Available from 01.06.2025

## VERTICAL SLIDING DOOR WITH SMOKE PROTECTION IN S<sub>200</sub> VERSION

Certified according to DIN EN 13501-2

- Smoke protection classification S<sub>a</sub> and S<sub>200</sub> according to DIN EN 13501-1EN
- Fire protection classes EI<sub>2</sub>30, EI<sub>2</sub>60 and EI<sub>2</sub>90
- Wicket / escape door optionally available

# Insulated doors

High-quality solutions for cold rooms and freezers

---

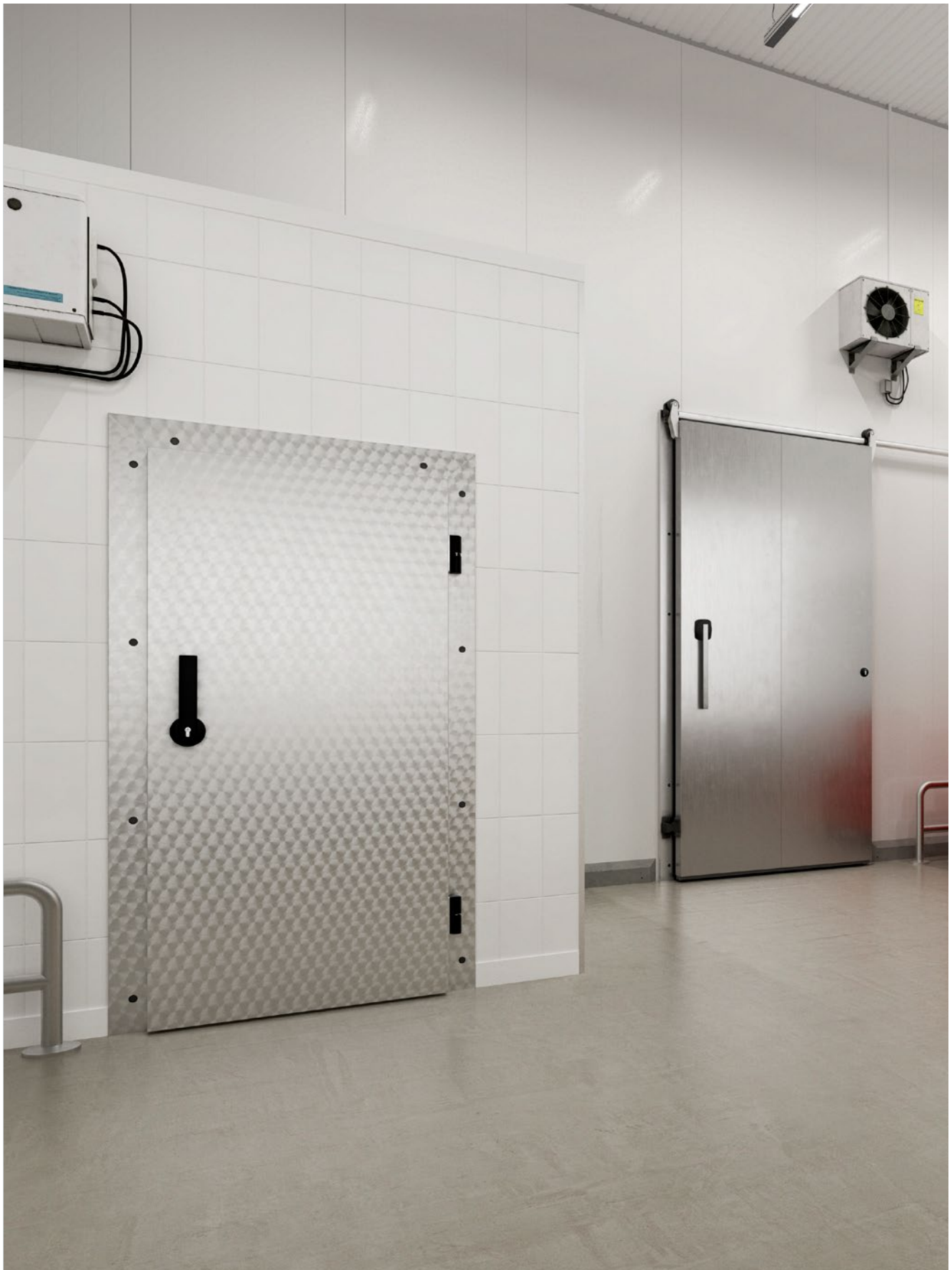



Available from 01.03.2025

## INSULATED DOORS FOR THE COLD ROOM AND FREEZER

As hinged or sliding doors for use in cold storage facilities, supermarkets or in the food industry

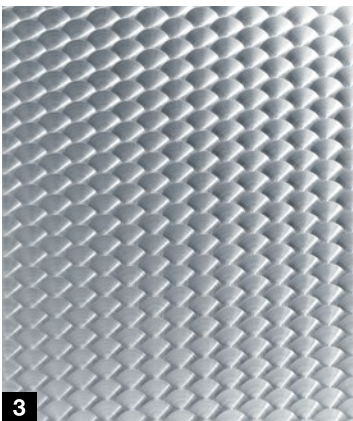

- Cold room hinged door HID-80 and cold room sliding door HIS-80 for cold rooms down to 0 °C
- 80 mm door leaf, foamed with polyurethane (PU)
- 2 surface finish versions: stainless steel (matt circular textured finish or polished finish) and galvanized steel (RAL 9002, optionally in RAL to choose)
- Thermo block frame 150 × 50 mm for fitting in brickwork and insulated panels
- Fitting in front of the wall
- Hinged door: max. 1150 mm × 2300 mm, with an all-round, easily replaceable seal
- Sliding door: max. 4000 mm × 2800 mm, manually operated, with a bottom guide or wall guide and optional bolt lock
- Combined solution of insulating sliding door and Hörmann double-action door PE or Hörmann high-speed door F 4020 Cold is possible
- Emergency operation of the bolt closing with fluorescent signage Door frame prepared for double-action door

- 1 Insulating hinged door
- 2 Insulating sliding door
- 3 Matt circular textured finish stainless steel
- 4 Polished stainless steel



# Products for commercial and industrial construction

**Hörmann. For Life.**





# High-speed doors with flexible curtain

Innovative technology ensures reliable function

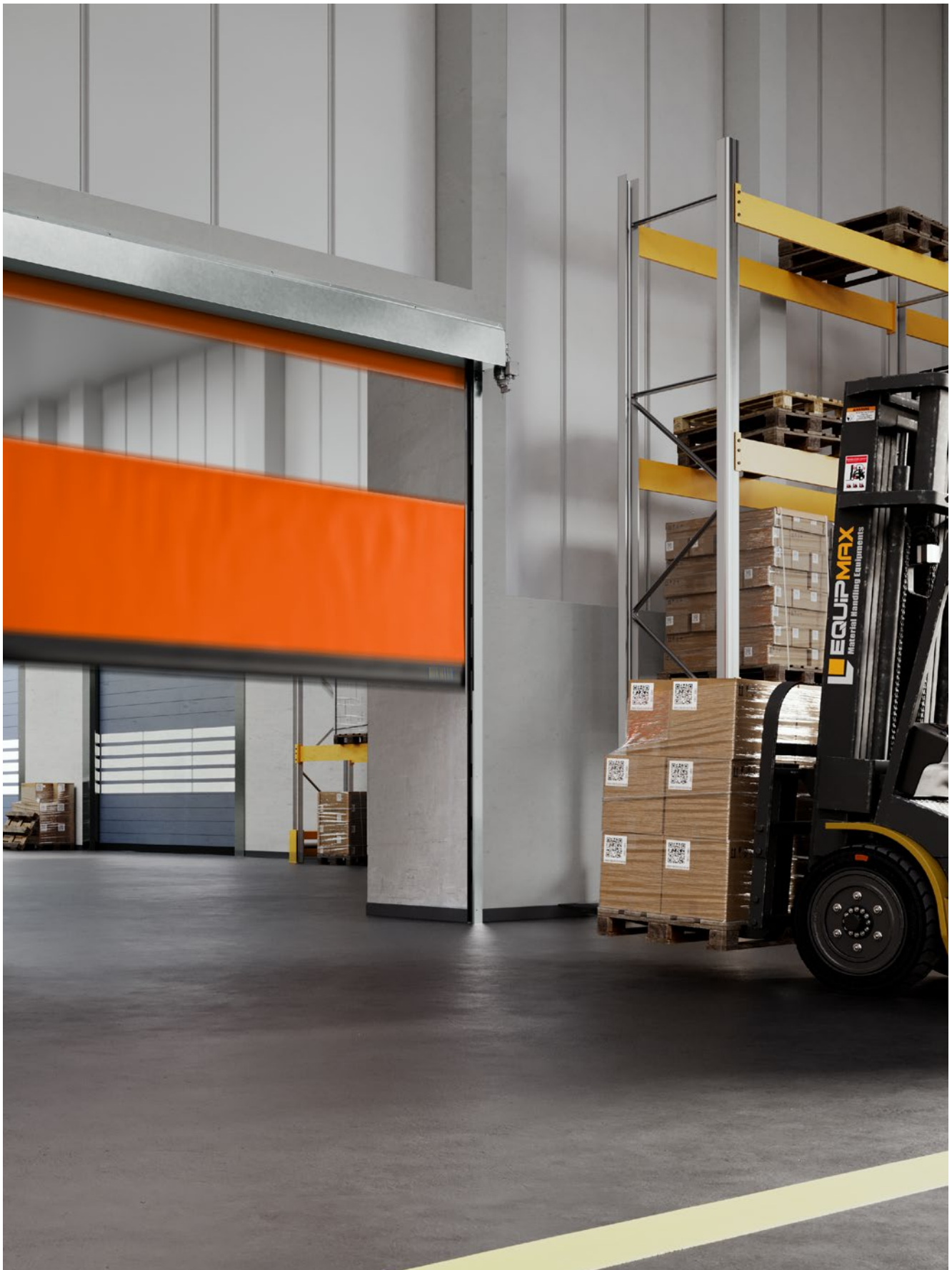



Available from 01.06.2025

## FLEXIBLE HIGH-SPEED DOOR V 5025 Z

Fast operational readiness after a crash  
thanks to automatic re-feed on both sides

- Crash function: automatic re-feed on both sides across the entire clear door height
- Zipper technology with zipper plastic slides in maintenance-free, spring-loaded plastic slide rails
- Attractive price-performance ratio
- Simple transport, easy fitting
- Extra narrow side element
- Internal and external door
- Maximum opening speed: 2.0 m/s
- Maximum closing speed: 1.0 m/s
- No reference run required after a power failure
- Safety light curtain as standard
- Resistance to wind load certified to DIN EN 12424: class 3
- Maximum size: 5000 × 5000 mm

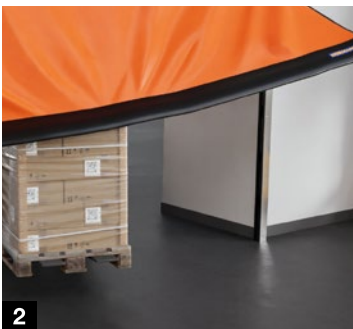
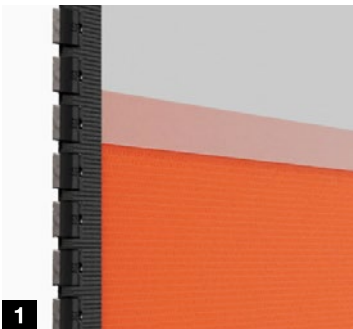

- 1 Door curtain with zipper technology
- 2 Crash function with automatic re-feed on both sides
- 3 Door with pulled out curtain is opened completely
- 4 Curtain is reinserted into the slide rail
- 5 Door is closed and ready for use again

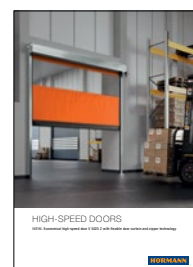

For further information, see the "High-speed doors" brochure.

# Spiral doors

World record speed ensures smooth processes



Already available

## HIGH-SPEED DOOR HS 5040 TURBOLUX S

Currently the fastest vertically opening industrial high-speed door in the world\*

- Maximum opening speed: > 4 m/s
- Maximum closing speed: 1 m/s
- Ensures fast and uninterrupted material flow and energy-efficient processes
- Particularly low-wear
- Operator designed for over one million cycles
- Door leaf 90 percent transparent
- Integrated safety light curtain for monitoring the door closing area
- Polycarbonate sections divided by aluminium profiles
- Maximum door size: 5000 × 5000 mm
- Available as an internal and external door

Only from Hörmann

Confirmed by the Record Institute for Germany (RID)

\* As at 13 November 2024, confirmed on 5 August 2024 by the Record Institute for Germany

# High-speed sectional doors and spiral doors

Elegant solution for easier fitting



Available from 01.03.2025

## HIGH-SPEED DOOR HS 5012 PU N 42 S

Ideal for confined fitting situations

- Attractive price-performance ratio
- Narrow side elements (215 mm) and low headroom requirement (min. 550 mm)
- Quiet door travel without springs and counter weights
- Reduces the wear and greatly reduced maintenance costs
- Excellent thermal insulation
- Maximum opening speed: approx. 1.2 m/s
- Maximum closing speed: 0.5 m/s
- Available as an internal and external door

Available from 01.06.2025

## SHAFT COVER AND OPERATOR COVER FOR SPIRAL DOORS

Lightweight and transparent

- Optional cladding made of impact-resistant polycarbonate
- Particularly lightweight, easy fitting and maintenance-friendly
- Standard colour: Smoke grey, optional film coating in the preferred colours Dark grey, Light grey, Blue, Orange and Yellow
- Max. door width: up to 7000 mm
- Can be situated internally or externally

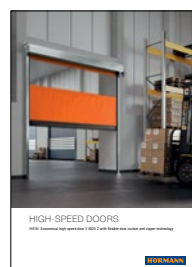

For further information, see the "High-speed doors" brochure.

## Industrial sectional doors

Overall harmonious appearance thanks to matching surface finish

---





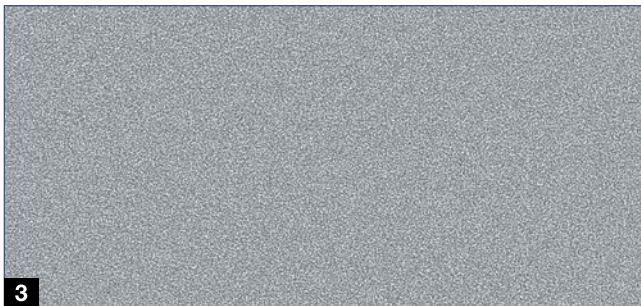
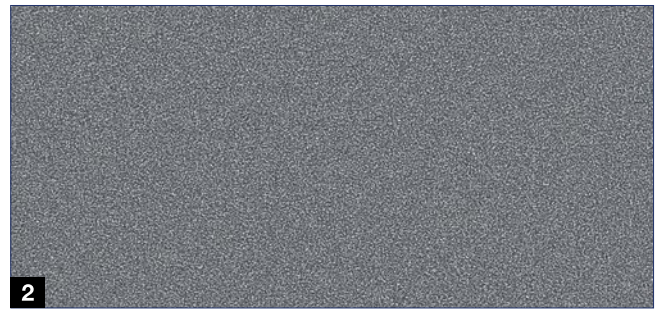

Available from 01.09.2025

## PLAINGRAIN SURFACE FINISH

### Overall harmonious appearance

- Smooth surface finish with low gloss level
- Modern with matt fine structure colours
- Robust, scratch-resistant and impact-resistant
- Matching combination of PU sections with Plaingrain surface finish and glazing frames in the same fine structure colours
- Available for all industrial sectional doors (except for ALR Vitraplan and ALR Vitraplan AT)

### 4 fine structure paints

- 1 RAL 9016 Traffic white, matt fine structure
- 2 RAL 9007 Grey aluminium, matt fine structure
- 3 RAL 9006 White aluminium, matt fine structure
- 4 RAL 7016 Anthracite grey, matt fine structure

# Industrial sectional doors

More design possibilities for beautiful door appearances

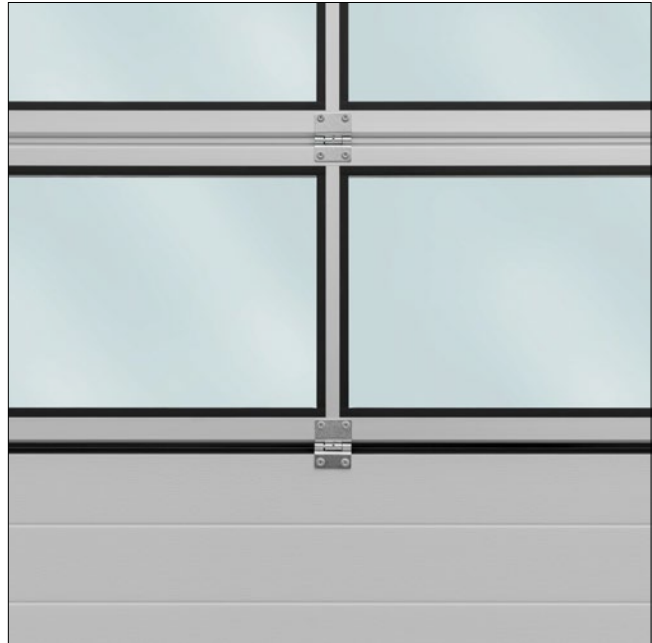

Available from 01.07.2025

## TRANSPARENT PROTECTIVE PAINT

UV protection keeps surfaces looking permanently beautiful

- Environmentally-friendly, water-based protective paint
- Protection from UV radiation and other environmental effects
- Virtually unchanged surface finish appearance after 10 years: loss of colour and gloss, weathering, greying or chalking are effectively prevented
- Available for all door types and door section types\*

**1** Weathering after 10 years without protective paint

**2** With protective paint

Available from 01.07.2025

## ALUMINIUM FRAME PAINTED ON ONE SIDE

Coloured on exterior, neutral on interior

- Neutral colour possible on the inside of the door with coloured outside
- Door sections in RAL 9002 Grey white on the inside, glazing frames anodised in colour E6/C0 on the inside
- More cost-effective than painting on both sides
- Available for all door types with aluminium glazing frames\*

\* Excluding ALR Vitraplan, ALR Vitraplan AT as well as doors with Decograin



Available from 01.07.2025

## TWO-COLOUR COATING

Regardless of door and door section type

- Flexible colour design for individual applications, such as visualisation of company colours
- Two-colour design regardless of door and door section type
- Available for all industrial sectional doors (except for ALR Vitraplan and ALR Vitraplan AT)



Available from 01.07.2025

## COLOUR COATING FOR ADD-ON PARTS AND INFILLS

harmonious interior view and additional protection

- Harmonious interior view of the door without colour differences
- Additional protection in case of particular stress (agriculture, chemical industry, sea)
- Available for end caps, door leaf reinforcements, centre hinges and stainless steel infills such as expanded mesh or perforated sheets

# Industrial sectional doors

Inexpensive alternative with easy fitting

---



Available from 01.07.2025

## TENSION SPRING TRACK APPLICATION

Shorter fitting time and low required headroom

- A cost-effective alternative to a torsion spring door
- Quick and easy fitting
- No centre shaft holder and no fixing in the lintel area required
- Small required headroom of just 200 mm for manually operated door version
- Available for doors up to max. 4000 mm × 4000 mm and 160 kg door leaf weight



# Shop door ShopRoller SR

Convenient solution for supermarkets and shopping centres



**Already available**

## SSG SR SLIDING CENTRE SUPPORT FOR SHOPROLLER SR

Efficient solution for large openings

- Closing large openings up to 21 metres clear width with up to 3 doors
- More cost-efficient in terms of purchase, delivery and fitting compared to special-size doors
- Easy to handle due to low-friction track
- Partial opening positions are possible, because the doors can be moved individually

**Already available**

## B 100 R IMPULSE CONTROL FOR SHOPROLLER SR

For convenient door opening in impulse operation

- Opening and closing the security rolling grille in press-and-release impulse operation
- Safety edge and safety photocell for reliable personal protection
- Optionally available with hand transmitter



For further information, see the "Shop door ShopRoller SR" brochure.

# Loading technology

Improved use of materials for long-lasting construction



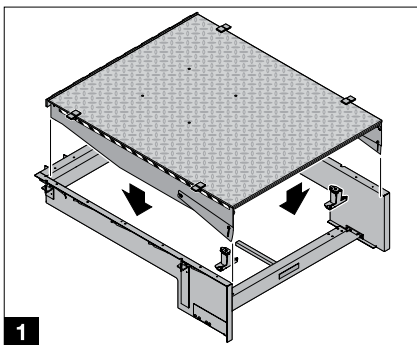

1

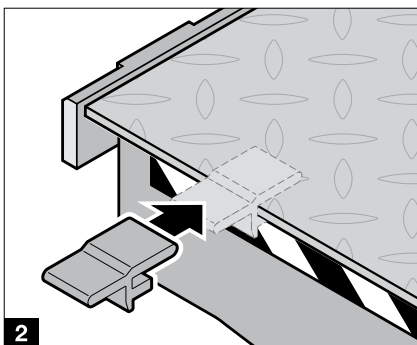

2

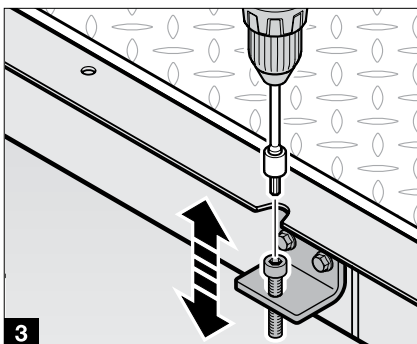

3

Available from 01.03.2025

### TELESCOPIC LIP DOCK LEVELLER HTL3

More robust, lighter, better

- More flexibility in planning and installation thanks to modular design
- Base frame BFT3 for retrofitting the dock leveller as the core model (platform, lip and hydraulics) 1
- Price advantage thanks to new standard length of 2250 mm
- Easy fitting thanks to positioning aids 2, cut-outs for welding seams and easily accessible adjustment angles for the alignment of casting frames 3
- Easy to maintain thanks to extra clearance below the dock leveller
- Lower transport costs thanks to space-saving transport concept
- Rated load up to 60 kN (for higher rated load: HTL2 100 kN)
- Approx. 10% lower carbon footprint due to lower weight



# Loading technology

Practical solutions for more security during loading



Available from 15.05.2025

## AUTOMATIC WHEEL-BLOCKING SYSTEM AWB

Suitable for all lorry types



- Security features for the loading site:  
securing the lorry against unintended rolling away / creeping
- Convenient impulse operation from inside the building:  
no personnel required in the manoeuvring range of the lorry
- **ONLY FROM HÖRMANN.** Hydraulic cylinders protected against dirt and adverse weather effects
- Blocking possible with any wheelbase (float zone 2825 mm)
- No collision with mudguards or cladding (blocking height 300 mm)
- Height-adjustable by up to 50 mm to compensate for slight unevenness
- Intuitive operation, rugged and reliable
- Easy fitting and installation
- Versions available for right and left
- System update, settings and reading of service information using mobile data and WiFi
- Stand-alone solution or integration in control system (560 S/T/V)
- Piezo signal transmitter for acoustic malfunction warnings
- Including LED control light, emergency stop and warning light





**Already available**

**IBS: AUTOMATIC INTERMEDIATE STOP FOR TELESCOPIC LIP DOCK LEVELLERS**

**More safety at the loading site**

- Automatic intermediate stop of the telescopic lip
- Safe approach to the vehicle to open lorry doors safely
- Then the lip is fully extended and lowered
- Adjustable extension depth via sensors underneath the dock leveller platform
- Suitable for connection to controls 560 T and 560 V
- Includes control extension with LED warning light



**Already available**

**PEDESTAL PV4 FOR DOCK LEVELLER HTLV4**

**More space for tailboards**

- Particularly compact and stable three-part steel construction for use in loading houses
- No restriction of the clearance below the dock leveller by pedestal components
- Depending on the ramp height, tailboard slot usable despite large installation height of the dock leveller
- Ramp dimensions (width × length): 3500 × 3000 – 4500 mm
- Ramp height: 795 – 1500 mm, for angled arrangement minimum 805 mm
- Lightweight and economical: also available in combination with pit model P

# Loading technology

Flexible docking with intelligent details

---

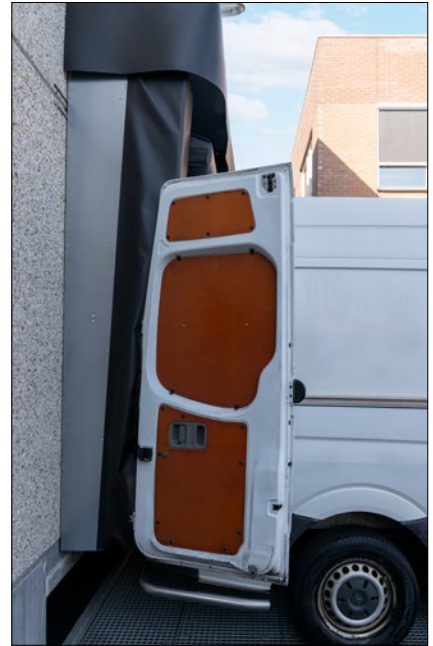

Available from 01.04.2025

## CUSHION DOCK SEAL BBS2

Dock seals for delivery vans

- Optimal sealing of the distance between vehicle and building, even with various vehicle dimensions
- Can be quickly and easily adapted to vehicle types and heights thanks to the adjustable top part and particularly flexible side cushions
- Universally applicable for all standard vans, including Mercedes Sprinter H1 / 2 / 3 / 4, Iveco Daily and VW Transporter



**Already available**

## **FLAP DOCK SHELTERS DSL BASIC AND DSLR BASIC**

**Attractively priced entry-level models**

- DSL Basic: sloping top part with 100 mm slope, optionally with rainwater drainage channel for faster drainage, recommended for high facades and long lorry idle times
- DSLR Basic: straight top part, with rainwater drainage channel as standard
- Dock model with link arm construction
- Standard size: 3300 × 3500 × 600 mm
- Side flaps: 500 mm, transversal strength due to monofilament for particularly good sealing
- Top and side flaps made of two-ply backing fabric



# Perimeter protection systems

**Hörmann. For Life.**









# Perimeter protection systems

Simple and inexpensive car park management



Available from 01.05.2025

## PARKING SPACE MANAGEMENT SYSTEM PARK NFC LITE

Cost-optimised and cashless

- Contactless payment of a flat rate upon entry and make use of the maximum parking time
- Only two major components: entry station **1** and barrier **2**
- Simple installation and initial start-up thanks to “virtual loops” with radar technology
- Low maintenance thanks to non-contact NFC technology
- Ideal for park and ride, inner city car parks and car parks run by municipal operators



**Already available**

### DOOR READER STATION

For easy access control via bank card

- 7" TFT colour display with touchscreen can optionally be used as advertising space
- Online data connection to central unit
- Prepared for installation of a secondary intercom



**Already available**

### RENUMERATION STATION

Discount on parking charge via bank card

- 3.5" TFT colour display with touch screen
- Enables selectable reimbursement options for the parking tariff (e.g. fee-based or time-based reimbursement)
- Network connection for integration into the Park NFC system

# Perimeter protection systems

Innovative solution for individual perimeter protection systems



## Already available

### RADAR SENSOR R-LOOP **1**

Reliable detection of people and vehicles

- Reliable detection of moving and stationary objects
- Safe differentiation between vehicles and people
- 2-in-1: replaces induction loop (vehicle detection, up to 8 m) and photocell (personal protection, up to 6 m)
- Versatile and easy to configure thanks to multilingual app (iOS and Android)

## Available from 01.03.2025

### HCAM DOME NUMBER PLATE RECOGNITION **2**

Flexible with zoom

- Wide range of fitting options and particularly easy to use
- Reading range thanks to zoom from 1 to 16 m (can be adjusted via software)
- Local stand-alone solution, no internet access, GDPR-compliant
- Can be used for barriers, doors and bollards





Available from 01.01.2025

## HCAM SMART NUMBER PLATE RECOGNITION

Camera with robust AI technology

- High-performance AI-based number plate recognition
- Very fast read rates, ideal for free-flow applications
- Integrated software with adjustable interfaces
- Smart, stand-alone solution, no internet connection required, GDPR-compliant



Available from 01.05.2025

## NEW BARRIER SH 30

Cost-effective barrier for quick installation

- Barrier width up to 5 metres
- 24 V DC motor with power limit, standard-compliant
- Quick and easy to install
- Perfectly suited for private or inner city accesses

**Only from Hörmann**



# Perimeter protection systems

Automatic plug & play bollards for private homes

---





**Available from 01.03.2025**

**AUTOMATIC BOLLARDS A 114-600 E 1 / A 114-800 E 2 “PLUG & PLAY”**

Ideal for private residential construction,  
e.g. in private driveways

- Ready-to-install plug & play bollard with integrated foundation box
- Fitting time of approx. 1 hour
- Can be retracted manually in case of a power failure
- Diameter: 114 mm
- Barrier heights: 600 and 800 mm
- Low power consumption and minimum maintenance

**Already available**

**NEW CERTIFICATION FOR MOBILE ROAD BLOCKER M30**

Fully certified in accordance with DIN SPEC 91414-1  
for mobile vehicle barriers

- Crash test M30 according to IWA 14-1 or ISO 22343-1:2023
- Displacement test 0.1 / 0.0 m
- Manipulation resistance class MK 2
- Maximum flexibility in the combination of modules
- Simple placement without fixing
- Quick installation and relocatable in approx. 20 minutes
- Quick and easy operation of the alarm contact element



# Digital services

For customised product information

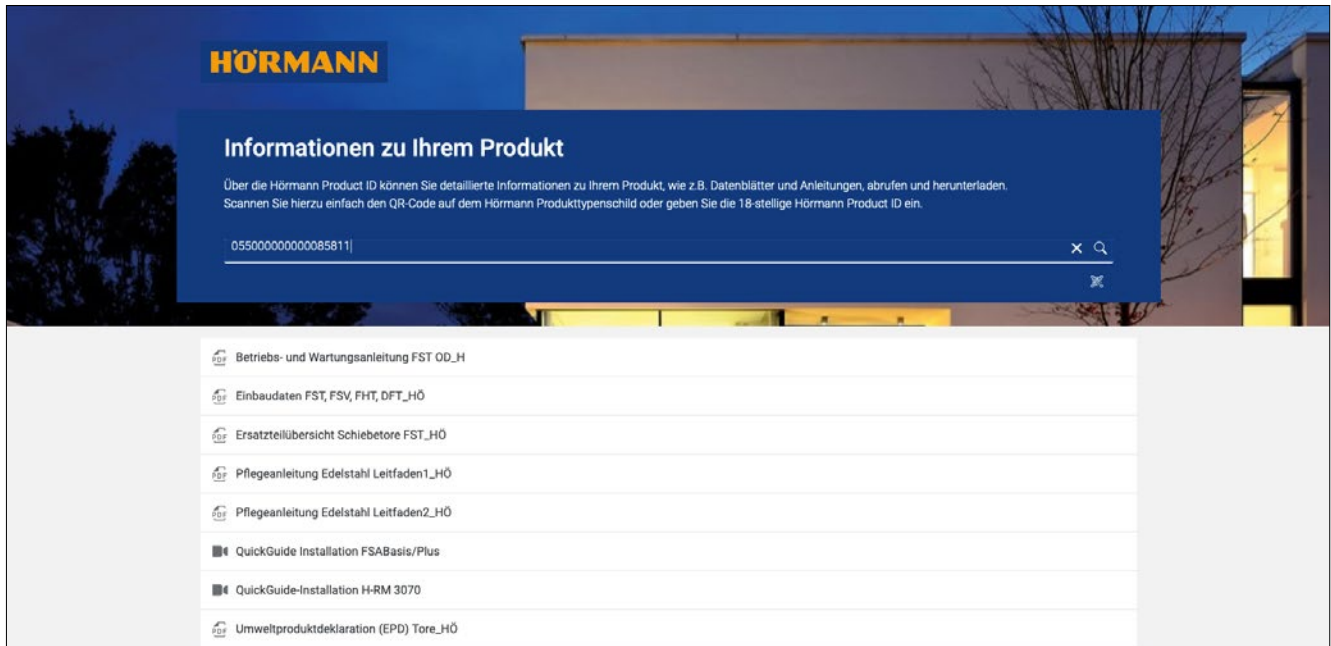

## HÖRMANN PRODUCT ID FOR RETRIEVING PRODUCT INFORMATION

Quick access via QR code

- All product information, such as fitting and maintenance instructions, approvals and care instructions, is available for easy download 24/7
- Hörmann Product ID for retrieving product information via QR code
- Available for steel construction project doors OD, steel and stainless steel construction project doors STS / STU, steel and stainless steel sliding doors FST, FlexFire textile fire protection curtain
- **NEW.** Available for aluminium box frame construction project doors, steel doors ZK / H8-5, aluminium entrance doors and steel / aluminium entrance doors



Fitting and maintenance instructions, approvals and care instructions for your product can be found at <https://productid.hoermann.com>



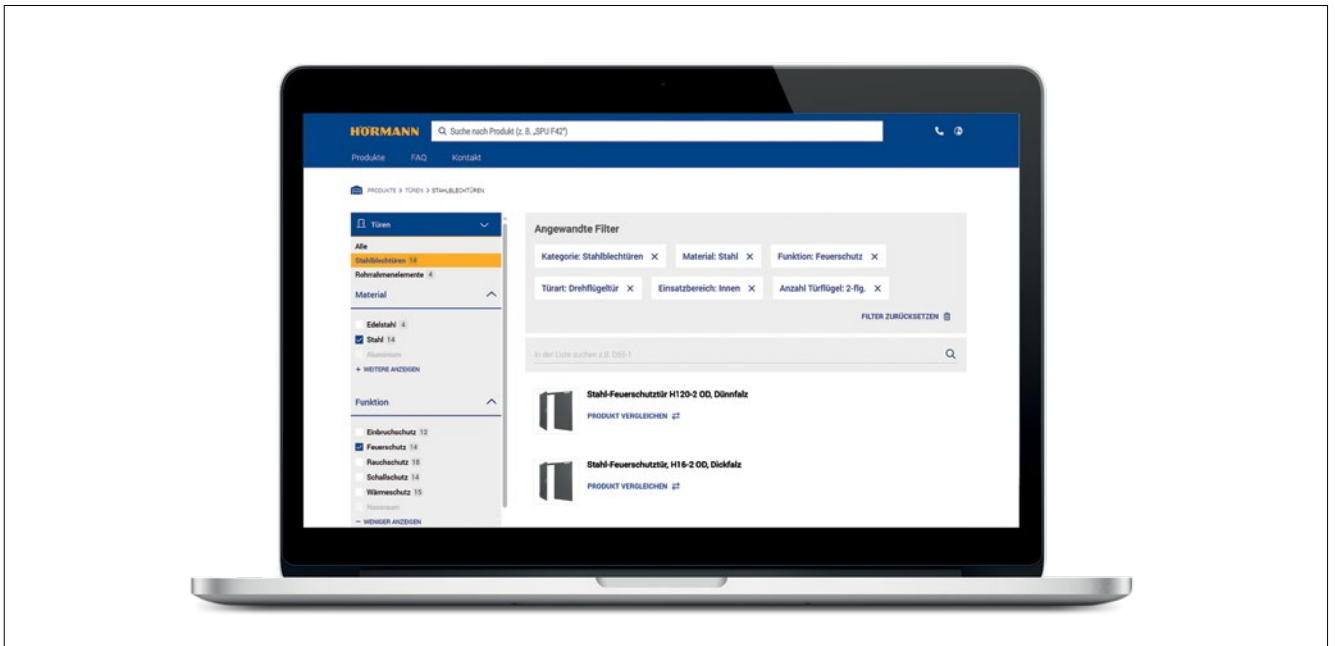

## HÖRMANN PRODUCT PORTAL

Find the right product quickly and easily

- Detailed product information from technical data and texts for invitation to tender to CAD drawings, BIM data, documents and videos
- Simple selection and search options as well as extensive filter functions
- Practical comparison view of up to three products from the same category



Texts for invitations to tender, CAD drawings, BIM data and documents for your project can be found at <https://hbp.hoermann.com/uk/portal>

# HÖRMANN

For Life. For Life. For Life. For Life.  
For Life. For Life. For Life. For Life.  
For Life. For Life. For Life. For Life.